

# DaVinci Custom Fireplace™

STYLE: RIGHT CORNER 102" x 58"

Electrical Req'd - 7A 120V    Gas Req'd - 116,000 BTU's

NG - Min = 5.5"wc (1.37kpa), Max = 7"wc (1.74 kpa)  
LP - Min = 11"wc (2.74 kpa), Max = 13"wc (3.23 kpa)

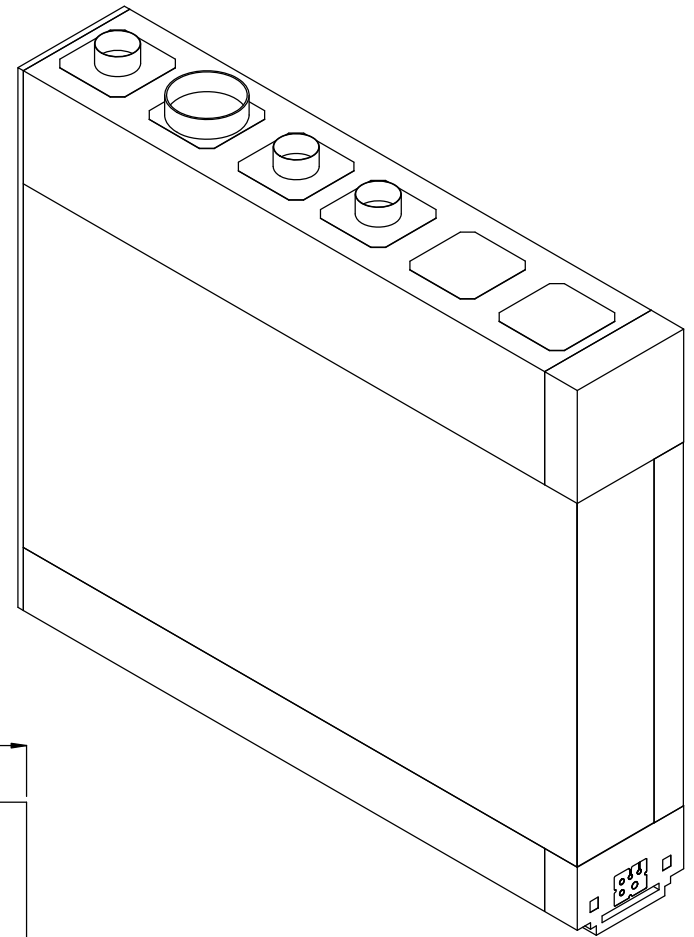
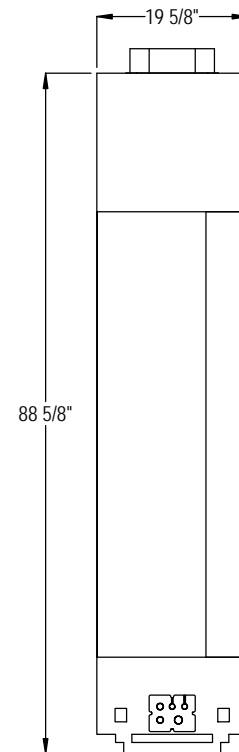
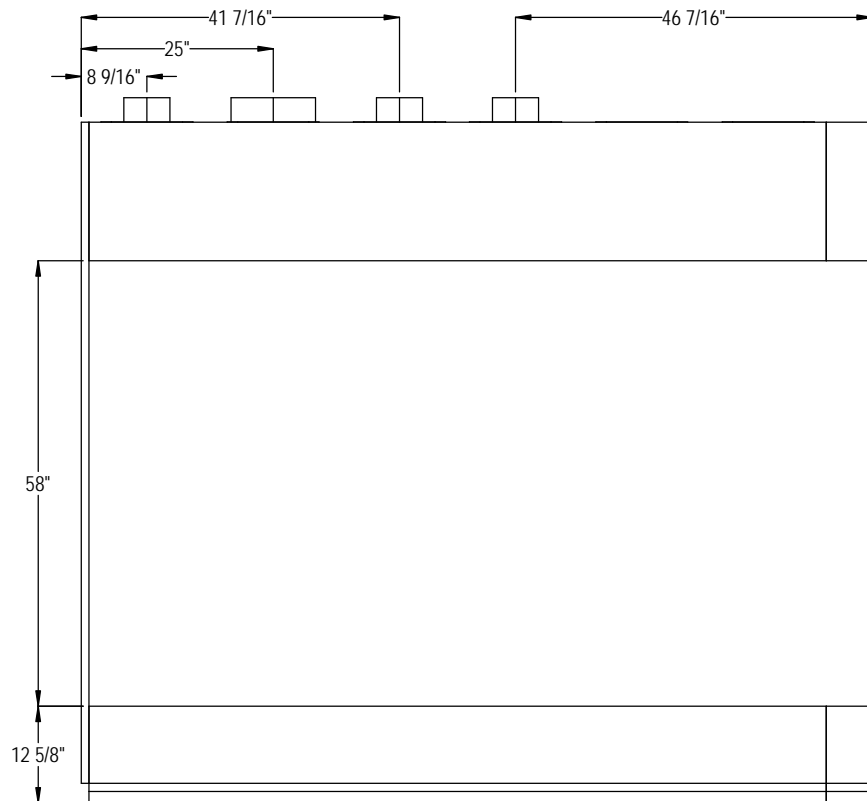
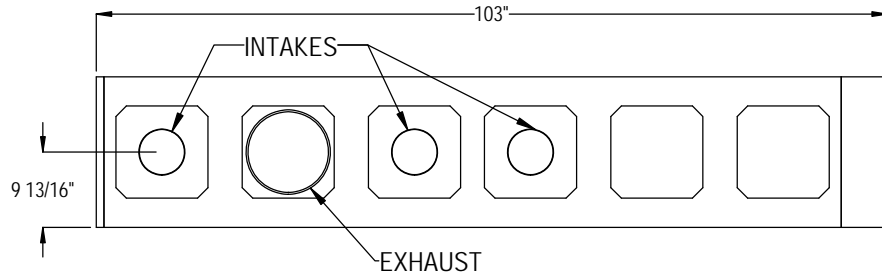

NOTE:  
INTAKE/EXHAUST DIMENSIONS SHOWN  
FOR LEFT SIDE GAS & ELECTRICAL